



Keyhole fenders

KEYHOLE FENDERS



Keyhole fenders are used worldwide and they offer very reliable protection for the bow of a vessel or for the wall of a quay. This type of fender is characterised by the keyhole-shaped opening on the inside and it is used in areas where large forces must be absorbed. Keyhole fenders are strong and they can be produced with a curve. The two mounting holes facilitate easy and accurate installation.

Types

Standard keyhole fenders are produced by length or as a block and they are made from highly wear-resistant rubber. Lengths are produced by means of extrusion and blocks by means of compression-moulding. Keyhole fenders are produced with a flat face or a grooved face, depending on the friction and/or grip required. As with the composition fender this type of fender can also be produced with an UHMW-PE surface layer. FenderTec keeps most standard sizes in stock for fast delivery. Custom sizes can also be supplied on request with short lead times. Keyhole fenders, W fenders and M fenders are not interchangeable.

Processing

Keyhole fenders are relatively easy to install. In general they are mounted vertically with fixing pins through the two standard holes. Keyhole fenders can be provided in specified lengths and the ends can be bevelled if required.

If the fenders are longer than one meter an opening for a support strip can be added.

Applications

Keyhole fenders are widely used in various sizes and designs on:

- tugboats
- barges
- workboats
- quays
- piers
- bridge sections



KEYHOLE FENDER LENGTH

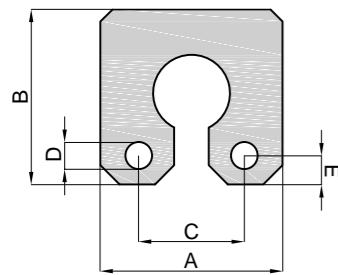
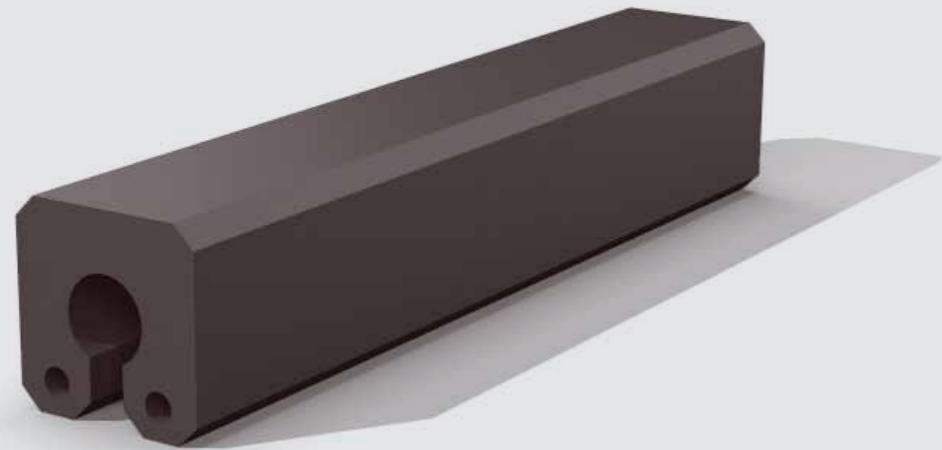

Standard dimensions

A (mm)	B (mm)	C (mm)	D (mm)	E (mm)	Weight (kg/m)	Length max. (mm)
100	100	70	16	16	8	2000
200	200	130	28	35	33	2000
250	250	150	33	50	54	2000
300	300	180	33	60	80	2000
350	350	210	33	70	114	2000

Other non-standard dimensions available on request.

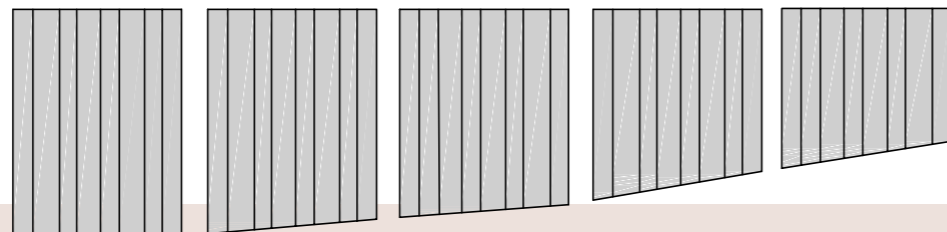
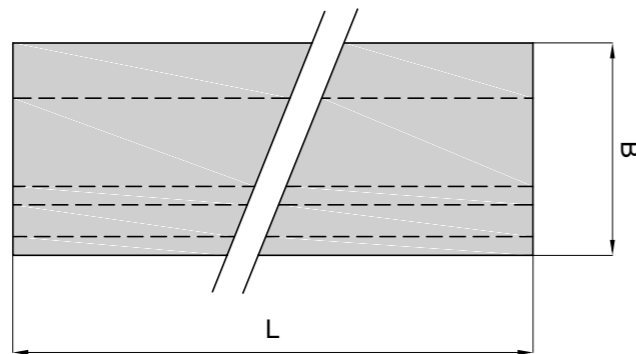
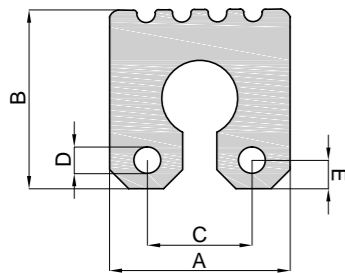

Bow fenderset cut to size



KEYHOLE FENDER BLOCK

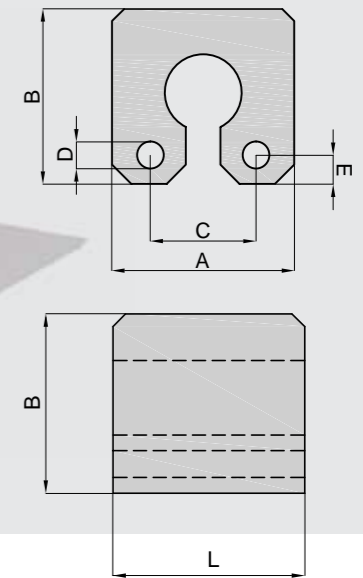
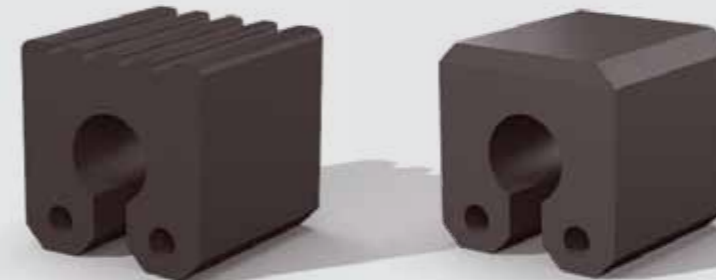

Standard dimensions

A (mm)	B (mm)	C (mm)	D (mm)	E (mm)	Weight (kg)	Length max. (mm)
200	200	130	28	35	7	200
250	250	150	33	50	13	250
300	300	180	33	60	24	300
350	350	210	33	70	40	350

Other non-standard dimensions available on request.

Mounting method and dimensions

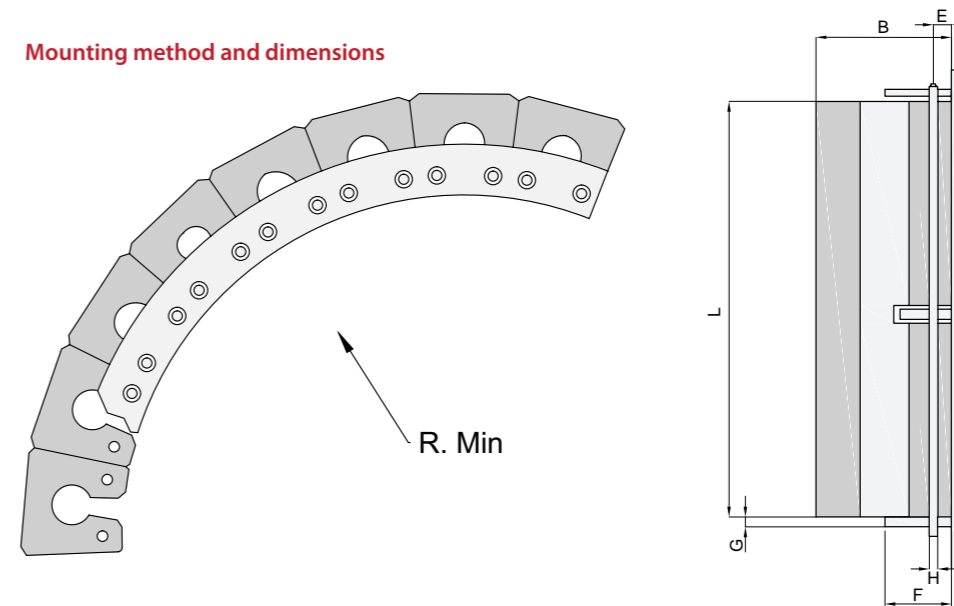

B (mm)	E (mm)	F (mm)	G (mm)	øH (mm)	L max. (mm)	Radius min. (R)
200	35	100	15	ø25	2000	450
250	50	125	20	ø30	2000	600
300	60	150	20	ø30	2000	800
350	70	175	25	ø30	2000	1000

General guidelines for mounting. For reference purposes only.



Your local representative:

